

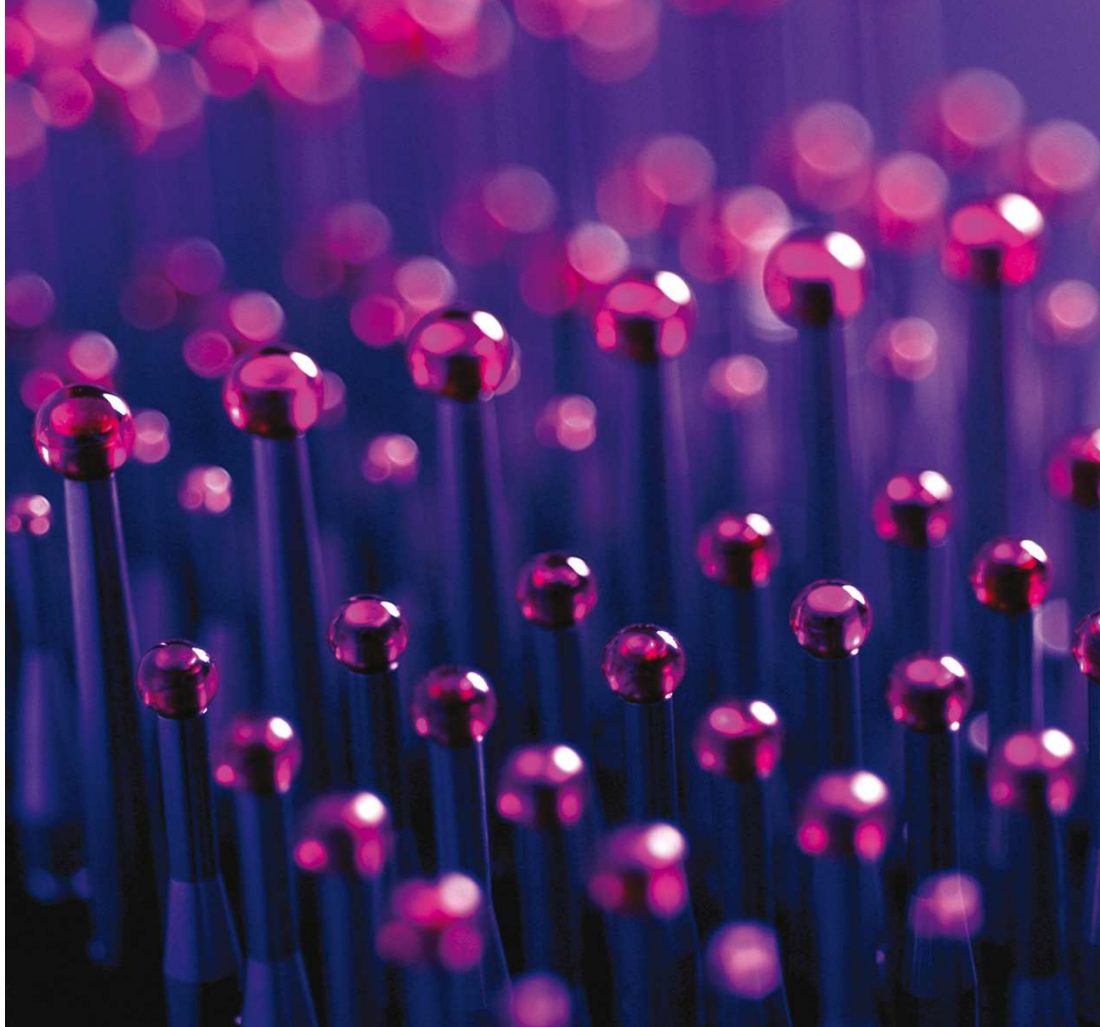

HEXAGON METROLOGY



TESASTAR STYLUS EUROPE PRICE LIST 2009



Validity: from January 1st to December 31st 2009

All prices are subject to our standard conditions of Sales

TESA reserves the right to make amendments to this price list wherever necessary.

You will find in the following document:

- TESA item reference number
- Item description
- Drawing quotation
- Material
- Rebate code
- End user prices given in €





HEXAGON METROLOGY

CONTENT

	PAGES
Straight Stylus, Ruby Balls	
M2 coupling thread, L=10mm	3
M2 coupling thread, L=20mm	3
M2 coupling thread, L=30mm	3
M2 coupling thread, L=40mm	3
M2 coupling thread, L=50mm	3
M3 coupling thread, L=10mm	3
M3 coupling thread, L=21mm	3
M3 coupling thread, L=30mm	4
M3 coupling thread, L=40mm	4
M3 coupling thread, L=50mm	4
M4 coupling thread, L=20mm	4
M4 coupling thread, L=50mm	4
M4 coupling thread, L=100mm	4
Disc Stylus	
M2 coupling thread	4
Pointer Stylus	
M2 coupling thread, L=30mm	4
Star Stylus	
M2 coupling thread, 5 ways	5
M2 coupling thread, 4 ways	5
M3 coupling thread, 5 ways	5
Hollow Ball Stylus	
M2 coupling thread	5
M3 coupling thread	5
Cylinder Stylus	
M2 coupling thread	5
Parallel Stylus	
M2 coupling thread	5
Crosspieces	
M2 coupling thread, 5 ways	6
M2 coupling thread, 5 ways	6
Extensions	
M2 coupling thread	6
M3 coupling thread	6
M4 coupling thread	6
Adapters	
M2-M3	6
M3-M2	6
M4-M3	6
Articulations	
M2	6
M3	6
Additional Accessories	
	7
Stylus Kits	
	7-8



HEXAGON METROLOGY

Stylus PROGRAM

Straight Stylus, Ruby Balls

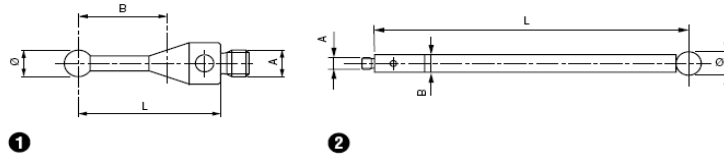

STRAIGHT STYLUS, RUBIS BALLS

M2 coupling thread, L=10mm									
TESA N°	Drawing N°	A	Dimensions			Weight g	Probe shaft	Rebate Code	End User price €
			Ø mm	L mm	B mm				
03969201	1	M2	1	10	4,5	0,3	Stainless steel	T6	28,00
03969202	1	M2	2	10	6	0,3	Stainless steel	T6	19,00
03969203	1	M2	3	10	7,5	0,4	Stainless steel	T6	19,00
03969204	1	M2	4	10	10	0,5	Stainless steel	T6	19,00
03969205	1	M2	5	10	10	0,7	Stainless steel	T6	27,00
03969206	1	M2	6	10	10	1	Stainless steel	T6	30,00
03969208	1	M2	8	11	11	1,5	Stainless steel	T6	46,00
03969225	1	M2	2,5	10	6	0,3	Stainless steel	T6	24,00
03969268	1	M2	0,3	10	2	0,3	Tungsten carbide	T6	137,00
03969267	1	M2	0,7	10	4	0,3	Tungsten carbide	T6	104,00
03969220	1	M2	0,5	10	3	0,3	Tungsten carbide	T6	65,00

M2 coupling thread, L=20mm									
TESA N°	Drawing N°	A	Dimensions			Weight g	Probe shaft	Rebate Code	End User price €
			Ø mm	L mm	B mm				
03969212	1	M2	2	20	14	0,5	Stainless steel	T6	19,00
03969213	1	M2	3	20	17	0,5	Stainless steel	T6	23,00
03969226	1	M2	2,5	20	14	0,4	Stainless steel	T6	25,00
03969272	1	M2	1,5	20	12,5	0,5	Tungsten carbide	T6	61,00
03969271	1	M2	1	20	12,5	0,41	Tungsten carbide	T6	61,00
03969269	1	M2	0,5	20	7	0,48	Tungsten carbide	T6	130,00
03969221	1	M2	1	20	7	0,6	Tungsten carbide	T6	38,00
03969222	1	M2	2	20	15	0,45	Tungsten carbide	T6	30,00

M2 coupling thread, L=30mm									
TESA N°	Drawing N°	A	Dimensions			Weight g	Probe shaft	Rebate Code	End User price €
			Ø mm	L mm	B mm				
03969259	1	M2	1	27	20,5	0,4	Tungsten carbide	T6	80,00
03969262	1	M2	2	30	25	0,99	Tungsten carbide	T6	61,00
03969263	1	M2	3	30	25	1,49	Tungsten carbide	T6	67,00
03969261	1	M2	1,5	30	25	0,58	Tungsten carbide	T6	67,00
03969286	2	M2	6	30	30	0,96	Carbon	T6	79,00

M2 coupling thread, L=40mm									
TESA N°	Drawing N°	A	Dimensions			Weight g	Probe shaft	Rebate Code	End User price €
			Ø mm	L mm	B mm				
03969282	1	M2	2	40	35	1,29	Tungsten carbide	T6	67,00
03969283	1	M2	3	40	35	1,97	Tungsten carbide	T6	73,00
03969284	1	M2	4	40	35	2,04	Tungsten carbide	T6	73,00

M2 coupling thread, L=50mm									
TESA N°	Drawing N°	A	Dimensions			Weight g	Probe shaft	Rebate Code	End User price €
			Ø mm	L mm	B mm				
03969293	1	M2	3	50	42,5	2,44	Tungsten carbide	T6	73,00
03969294	1	M2	4	50	42,5	2,52	Tungsten carbide	T6	73,00
03969295	1	M2	5	50	42,5	3,75	Tungsten carbide	T6	73,00
03969223	1	M2	3	50	42,5	0,83	Ceramic	T6	78,00
03969224	1	M2	4	50	42,5	0,91	Ceramic	T6	78,00
03969260	2	M2	4	50	3	1	Carbon	T6	94,00
03969276	2	M2	6	50	50	1,2	Carbon	T6	101,00

M3 coupling thread, L=10mm									
TESA N°	Drawing N°	A	Dimensions			Weight g	Probe shaft	Rebate Code	End User price €
			Ø mm	L mm	B mm				
03969324	1	M3	3	10	-	-	Stainless steel	T6	24,00
03969326	1	M3	6	10	-	-	Stainless steel	T6	33,00

M3 coupling thread, L=21mm									
TESA N°	Drawing N°	A	Dimensions			Weight g	Probe shaft	Rebate Code	End User price €
			Ø mm	L mm	B mm				
03969301	1	M3	1	21	4	1,1	Stainless steel	T6	29,00
03969302	1	M3	2	21	8	1,1	Stainless steel	T6	19,00
03969303	1	M3	3	21	12	1,1	Stainless steel	T6	19,00
03969304	1	M3	4	21	17	1,4	Stainless steel	T6	21,00
03969305	1	M3	5	21	21	1,55	Stainless steel	T6	27,00
03969310	1	M3	0,5	21	3	1,1	Tungsten carbide	T6	66,00
03969312	1	M3	2	21	15	0,8	Tungsten carbide	T6	28,00
03969332	1	M3	2,5	21	12,5	1,3	Tungsten carbide	T6	61,00



HEXAGON METROLOGY

STRAIGHT STYLUS, RUBIS BALLS

Straight Stylus, Ruby Balls

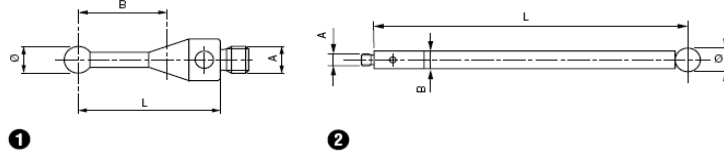

M3 coupling thread, L=30mm									
TESA N°	Drawing N°	A	Dimensions			Weight g	Probe shaft	Rebate Code	End User price €
			Ø mm	L mm	B mm				
03969333	1	M3	3	31	22	1,4	Stainless steel	T6	19,00
03969334	1	M3	4	31	27	2	Stainless steel	T6	23,00
03969335	1	M3	5	31	31	2,5	Stainless steel	T6	28,00
03969322	1	M3	23	30	22,5	1,3	Tungsten carbide	T6	32,00
03969323	1	M3	2,5	30	22,5	1,4	Tungsten carbide	T6	32,00
03969342	1	M3	3	30	22,5	1,81	Tungsten carbide	T6	61,00
03969313	1	M3	3	30	22,5	1,83	Tungsten carbide	T6	67,00

M3 coupling thread, L=40mm									
TESA N°	Drawing N°	A	Dimensions			Weight g	Probe shaft	Rebate Code	End User price €
			Ø mm	L mm	B mm				
03969343	1	M3	3	40	32,5	2,3	Tungsten carbide	T6	73,00

M3 coupling thread, L=50mm									
TESA N°	Drawing N°	A	Dimensions			Weight g	Probe shaft	Rebate Code	End User price €
			Ø mm	L mm	B mm				
03969353	1	M3	3	50	42,5	2,78	Tungsten carbide	T6	73,00

M4 coupling thread, L=20mm									
TESA N°	Drawing N°	A	Dimensions			Weight g	Probe shaft	Rebate Code	End User price €
			Ø mm	L mm	B mm				
03969402	1	M4	2	19	8	2,3	Stainless steel	T6	43,00

M4 coupling thread, L=50mm									
TESA N°	Drawing N°	A	Dimensions			Weight g	Probe shaft	Rebate Code	End User price €
			Ø mm	L mm	B mm				
03969408	1	M4	8	50	-	5,4	Ceramic	T6	90,00

M4 coupling thread, L=100mm									
TESA N°	Drawing N°	A	Dimensions			Weight g	Probe shaft	Rebate Code	End User price €
			Ø mm	L mm	B mm				
03969418	1	M4	8	100	-	7	Ceramic	T6	109,00

DISC STYLUS

Disc Stylus

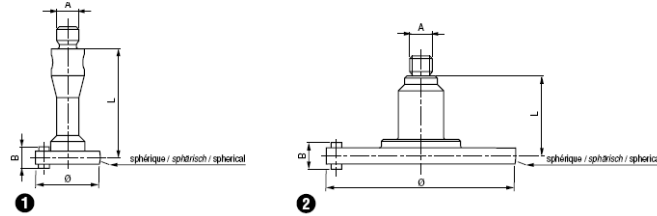

M2 coupling thread									
TESA N°	Drawing N°	A	Dimensions			Weight g	Probe shaft	Rebate Code	End User price €
			Ø mm	L mm	B mm				
03969241	1	M2	6	10	2	0,6	Stainless Steel	T6	74,00
03969242	1	M2	18	7,55	2,5	3,1	Stainless Steel	T6	52,00
03969243	2	m2	18	3,7	3	2,7	Stainless Steel	T6	103,00

POINTER STYLUS

Pointer Stylus

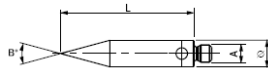

M2 coupling thread, L=30mm									
TESA N°	Drawing N°	A	Dimensions			Weight g	Probe shaft	Rebate Code	End User price €
			Ø mm	L mm	B mm				
03969200	-	M2	3	15	30	0,7	Stainless Steel	T6	24,00
03969141	-	M2	1,4	10	30	1	Tungsten Carbide	T6	41,20



HEXAGON METROLOGY

STAR STYLUS

Star Stylus

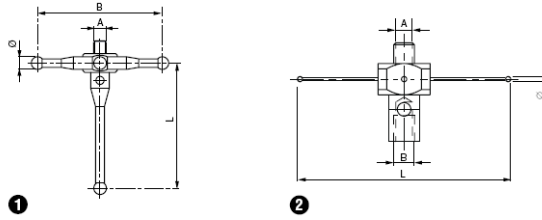

M2 coupling thread, 5 ways									
TESA N°	Drawing N°	A	Dimensions			Weight g	Probe shaft	Rebate Code	End User price €
			Ø mm	L mm	B mm				
03969081	1	M2	2	18	20	1,3	Stainless Steel	T6	94,00
03969055	1	M2	2	20	20	1,5	Stainless Steel	T6	73,00
03969082	1	M2	2	18	30	1,7	Stainless Steel	T6	94,00
03969056	1	M2	2	20	30	1,8	Stainless Steel	T6	76,00

M2 coupling thread, 4 ways									
TESA N°	Drawing N°	A	Dimensions			Weight g	Probe shaft	Rebate Code	End User price €
			Ø mm	L mm	B mm				
03969210	2	M2	0,5	20	M2	0,7	Stainless Steel	T6	178,00

M3 coupling thread, 5 ways									
TESA N°	Drawing N°	A	Dimensions			Weight g	Probe shaft	Rebate Code	End User price €
			Ø mm	L mm	B mm				
03969083	1	M3	2	18	20	2,2	Stainless Steel	T6	96,00
03969057	1	M3	2	20	20	2,2	Stainless Steel	T6	73,00
03969084	1	M3	2	18	30	2,5	Stainless Steel	T6	96,00
03969058	1	M3	2	20	30	2,5	Stainless Steel	T6	76,00

HOLLOW BALL STYLUS

Hollow Ball Stylus

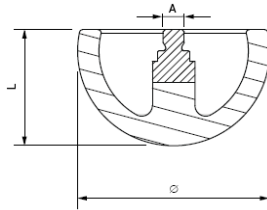

M2 coupling thread									
TESA N°	Drawing N°	A	Dimensions			Weight g	Probe shaft	Rebate Code	End User price €
			Ø mm	L mm	B mm				
03969218	-	M2	18	11	-	3,3	Ceramic	T6	257,00

M3 coupling thread									
TESA N°	Drawing N°	A	Dimensions			Weight g	Probe shaft	Rebate Code	End User price €
			Ø mm	L mm	B mm				
03969330	-	M3	30	17	-	13	Ceramic	T6	416,00

CYLINDER STYLUS

Cylinder Stylus

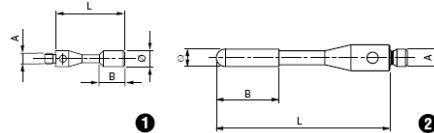

M2 coupling thread									
TESA N°	Drawing N°	A	Dimensions			Weight g	Probe shaft	Rebate Code	End User price €
			Ø mm	L mm	B mm				
03969253	1	M2	3	13	4	0,5	Stainless Steel	T6	25,00
03969251	1	M2	1,5	11	1,5	0,3	Stainless Steel	T6	63,00
03969252	1	M2	3	13	3,8	0,6	Stainless Steel	T6	59,00
03969292	2	M2	2	20	7,2	0,5	Tungsten Carbide	T6	169,00

PARRALLEL STYLUS

Parallel Stylus

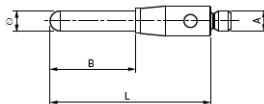

M2 coupling thread									
TESA N°	Drawing N°	A	Dimensions			Weight g	Probe shaft	Rebate Code	End User price €
			Ø mm	L mm	B mm				
03969277	-	M2	0,5	15,3	7,8	0,3	Tungsten Carbide	T6	177,00
03969278	-	M2	1	35,5	29,8	0,7	Tungsten Carbide	T6	146,00
03969279	-	M2	2	16	8,5	0,8	Tungsten Carbide	T6	132,00
03969280	-	M2	2	40	32	2	Tungsten Carbide	T6	80,00
03969281	-	M2	3	22,5	-	2	Tungsten Carbide	T6	132,00



HEXAGON METROLOGY

CROSS PIECES

Cross pieces

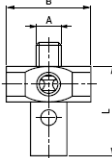

M2 coupling thread, 5 ways									
TESA N°	Drawing N°	A	Dimensions			Weight	Probe shaft	Rebate Code	End User price
			Ø mm	L mm	B mm	g			€
03969054	-	M2	-	7,5	7	1,1	Stainless Steel	T6	19,00

M3 coupling thread, 5 ways									
TESA N°	Drawing N°	A	Dimensions			Weight	Probe shaft	Rebate Code	End User price
			Ø mm	L mm	B mm	g			€
03969046	-	M3	-	13	10	3,7	Stainless Steel	T6	19,00

EXTENSIONS

Extensions

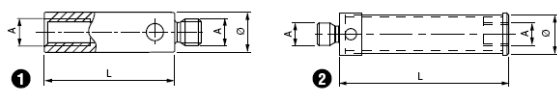

M2 coupling thread									
TESA N°	Drawing N°	A	Dimensions			Weight	Probe shaft	Rebate Code	End User price
			Ø mm	L mm	B mm	g			€
03969231	1	M2	-	10	-	0,5	Stainless Steel	T6	6,00
03969232	1	M2	-	20	-	1	Stainless Steel	T6	7,20
03969233	1	M2	-	30	-	1,6	Stainless Steel	T6	16,00
03969230	1	M2	3	5	-	-	Stainless Steel	T6	16,00
03969234	1	M2	3	40	-	1,8	Stainless Steel	T6	18,50
03969247	1	M2	3	50	-	1,51	Ceramic	T6	78,00
03969246	1	M2	3	40	-	1,22	Ceramic	T6	76,00
03969238	1	M2	3	50	-	1	Carbon	T6	90,00
03969239	1	M2	3	70	-	1,3	Carbon	T6	94,00
03969240	1	M2	3	90	-	1,5	Carbon	T6	98,00
03969270	1	M2	3	40	-	0,9	Carbon	T6	92,00

M3 coupling thread									
TESA N°	Drawing N°	A	Dimensions			Weight	Probe shaft	Rebate Code	End User price
			Ø mm	L mm	B mm	g			€
03969044	1	M3	-	10	-	0,8	Stainless Steel	T6	7,20
03969045	1	M3	-	20	-	1,8	Stainless Steel	T6	7,80
03969320	1	M3	-	35	-	2,9	Stainless Steel	T6	18,50

M4 coupling thread									
TESA N°	Drawing N°	A	Dimensions			Weight	Probe shaft	Rebate Code	End User price
			Ø mm	L mm	B mm	g			€
03969401	2	M4	7	30	-	5,1	Ceramic	T6	75,00

ADAPTERS

Adapters

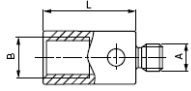

M2-M3									
TESA N°	Drawing N°	A	Dimensions			Weight	Probe shaft	Rebate Code	End User price
			Ø mm	L mm	B mm	g			€
03969061	-	M2	-	7	M3	0,5	Stainless Steel	T6	8,20

M3-M2									
TESA N°	Drawing N°	A	Dimensions			Weight	Probe shaft	Rebate Code	End User price
			Ø mm	L mm	B mm	g			€
03969062	-	M3	-	5	M2	0,5	Stainless Steel	T6	8,20

M4-M3									
TESA N°	Drawing N°	A	Dimensions			Weight	Probe shaft	Rebate Code	End User price
			Ø mm	L mm	B mm	g			€
03969403	-	M4	-	9	M3	1,4	Stainless Steel	T6	40,00

ARTICULATIONS

Articulations

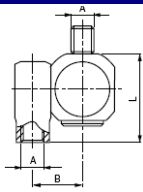

M2									
TESA N°	Drawing N°	A	Dimensions			Weight	Probe shaft	Rebate Code	End User price
			Ø mm	L mm	B mm	g			€
03969059	-	M2	-	8	4,5	1,7	Stainless Steel	T6	36,00

M3									
TESA N°	Drawing N°	A	Dimensions			Weight	Probe shaft	Rebate Code	End User price
			Ø mm	L mm	B mm	g			€
03969060	-	M3	-	12	6	3,8	Stainless Steel	T6	36,00



HEXAGON METROLOGY

ADD. ACCESSORIES

Additional Accessories

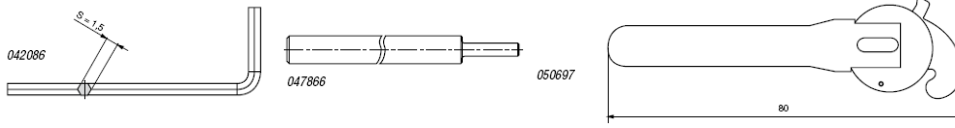

TESA N°	Drawing N°	Rebate Code	End User price €
042086	Socket head key, 1,5mm	T6	0,45
047866	M2-M3 stylus key	T6	9,80
050697	Key for carbon-fiber Stylus	T6	100,00

STYLUS KIT PROGRAM

STYLUS KITS

Part Number	Description	LIST PRICE Price	Rebate code	Qty
03969086	Stylus kit 8 - M2	657	T6	
047866	Tool key for stylus			2
049652	Tool key			2
050697	Tool key			2
03969054	5-way crosspiece, M2			1
03969082	5-way star stylus, M2			1
03969085	storage case for accessories			1
03969202	stylus, dia 2mm, ruby ball, M2			1
03969204	stylus, dia 4mm, ruby ball, M2			1
03969212	stylus, dia 2mm, ruby ball, M2			2
03969213	stylus, dia 3mm, ruby ball, M2			2
03969221	stylus dia 1mm, ruby ball, tungsten, M2			1
03969231	Extension, L10mm, M2			1
03969232	Extension, L20mm, M2			1
03969260	stylus, L50mm, carbon, M2			1
03969270	Extension, carbon, L40mm, M2			1

Part Number	Description	LIST PRICE Price	Rebate code	Qty
03969075	Stylus kit 1 - M2	595	T6	
047866	Tool key for stylus			1
03969054	5-way crosspiece, M2			1
03969081	5-way star stylus, M2			1
03969078	Storage case for accessories			1
03969201	stylus, dia 1mm, ruby ball, M2			2
03969202	stylus, dia 2mm, ruby ball, M2			4
03969203	stylus, dia 3mm, ruby ball, M2			2
03969204	stylus, dia 4mm, ruby ball, M2			1
03969206	stylus, dia 6mm, ruby ball, M2			1
03969212	stylus, dia 2mm, ruby ball, M2			2
03969213	stylus, dia 3mm, ruby ball, M2			2
03969214	stylus, dia 4mm, ruby ball, M2			1
03969230	Extension, L5mm, M2			2
03969231	Extension, L10mm, M2			2
03969232	Extension, L20mm, M2			2
03969233	Extension, L30mm, M2			2
03969253	Cylindrical stylus			1

Part Number	Description	LIST PRICE Price	Rebate code	Qty
03969040	TESASTAR Accessory kit M3	117	T6	
03969044	Extension, L10mm, M3			1
03969045	Extension, L20mm, M3			1
03969046	5-way crosspiece, M3			1
03969047	Mounted probe, dia 6.35mm			1
03969302	stylus, dia 2mm, ruby ball, M3			1
03969303	stylus, dia 3mm, ruby ball, M3			1
03969304	stylus, dia 4mm, ruby ball, M3			1

Part Number	Description	LIST PRICE Price	Rebate code	Qty
03969102	TESASTAR Accessory kit 3 M3	110	T6	
03969044	Extension, L10mm, M3			1
03969045	Extension, L20mm, M3			1
03969046	5-way crosspiece, M3			1
03969302	stylus, dia 2mm, ruby ball, M3			1
03969303	stylus, dia 3mm, ruby ball, M3			1
03969304	stylus, dia 4mm, ruby ball, M3			1

Part Number	Description	LIST PRICE Price	Rebate code	Qty
03969063	Stylus kit 3 - M2	369	T6	
042086	Socket head key, 1,5mm			1
047866	Tool key for stylus			2
03969082	5-way star stylus, M2			1
03969059	Articulation, M2			1
03969078	storage case for accessories			1
03969201	stylus, dia 1mm, ruby ball, M2			1
03969202	stylus, dia 2mm, ruby ball, M2			1
03969203	stylus, dia 3mm, ruby ball, M2			1
03969212	stylus, dia 2mm, ruby ball, M2			1
03969213	stylus, dia 3mm, ruby ball, M2			1
03969231	Extension, L10mm, M2			2
03969241	Disc stylus, dia 6mm, L10mm, M2			1
03969242	Disc stylus, dia 18mm, L7.55mm, M2			1



HEXAGON METROLOGY

STYLUS KITS

Part Number	Description	LIST PRICE Price	Rebate code	Qty
03969076	Stylus kit 7 - M2	530	T6	
042086	Socket head key, 1.5mm			1
047866	Tool key for stylus			2
03969054	5-way crosspiece, M2			1
03969082	5-way star stylus, M2			1
03969059	Articulation, M2			1
03969078	storage case for accessories			1
03969201	stylus, dia 1mm, ruby ball, M2			2
03969202	stylus, dia 2mm, ruby ball, M2			6
03969203	stylus, dia 3mm, ruby ball, M2			2
03969204	stylus, dia 4mm, ruby ball, M2			2
03969212	stylus, dia 2mm, ruby ball, M2			2
03969213	stylus, dia 3mm, ruby ball, M2			1
03969214	stylus, dia 4mm, ruby ball, M2			1
03969221	stylus dia 1mm, ruby ball, tungsten, M2			1
03969231	Extension, L10mm, M2			2
03969232	Extension, L20mm, M2			1

Part Number	Description	LIST PRICE Price	Rebate code	Qty
03969101	TESASTAR Accessory kit 2 M3	155	T6	
03969044	Extension, L10mm, M3			2
03969045	Extension, L20mm, M3			1
03969046	5-way crosspiece, M3			1
03969302	stylus, dia 2mm, ruby ball, M3			1
03969303	stylus, dia 3mm, ruby ball, M3			4
03969304	stylus, dia 4mm, ruby ball, M3			1

Part Number	Description	LIST PRICE Price	Rebate code	Qty
03969087	Stylus kit - M2	94	T6	
03969201	stylus, dia 1mm, ruby ball, M2			1
03969202	stylus, dia 2mm, ruby ball, M2			1
03969203	stylus, dia 3mm, ruby ball, M2			1
03969204	stylus, dia 4mm, ruby ball, M2			1
03969231	Extension, L10mm, M2			1
03969232	Extension, L20mm, M2			1
03969233	Extension, L30mm, M2			1

